

Valena™ Allure Connected starter pack

Cat. No(s): 7 525 96 - 7 526 96 - 7 527 96 - 7 528 96 - 7 529 96
 7 525 86 - 7 526 86 - 7 527 86 - 7 528 86 - 7 529 86

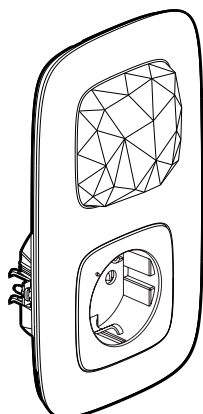

7 525 96

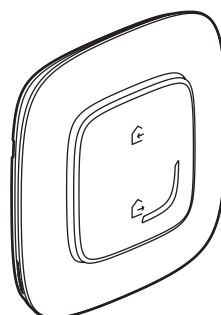

7 525 86

1. USE

This pack enables you to create a connected installation in your home.

It can be used to control lighting, roller shutters and electrical equipment plugged into connected sockets:

- using your smartphone and the Home + Control app
- using voice assistants
- from the general control at the entrance to your home

Comprises:

• A Control socket (Zigbee relay/WiFi)

Installation in 1-gang box 40 mm deep (minimum), instead of a standard socket outlet.

Claw and/or screw fixing.

Connected socket which can be controlled by a wireless lighting control and/or remotely via your smartphone.

The socket can be used to measure instantaneous and total consumption of the connected device, which can be viewed on the Home + Control app.

One-piece mechanism (grid + mechanism).

• A wireless general control, used to control leaving home/coming home scenes involving lights, roller shutters and connected sockets.

- Fixes directly on the wall or screws onto a flush-mounting box. Multi-gang versions can be combined with other wiring accessories.

- Fits on a piece of furniture (movable).

2. RANGE

Description	White	Ivory	Aluminium	Black	Pearl
German standard connected relay socket. Supplied complete with finishing plate and site protection cover. Equipped with a RESET button (hidden) used to return to factory settings.	7 525 96	7 526 96	7 527 96	7 528 96	7 529 96
Additional wireless general control. Supplied complete with battery, finishing plate. Equipped with an LED indicator (configuration) and a RESET button (hidden) used to return to factory settings. Repositionable self-adhesive fixings supplied.	7 525 86	7 526 86	7 527 86	7 528 86	7 529 86

3. DIMENSIONS (mm)

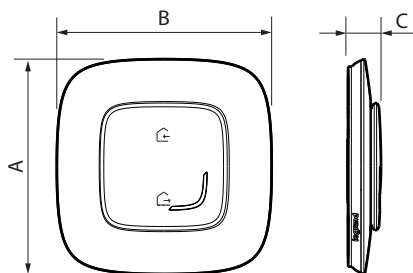

References	A	B	C
7 525 86 - 7 526 86 - 7 527 86 - 7 528 86 - 7 529 86	90	90	14

3. DIMENSIONS (mm) (continued)

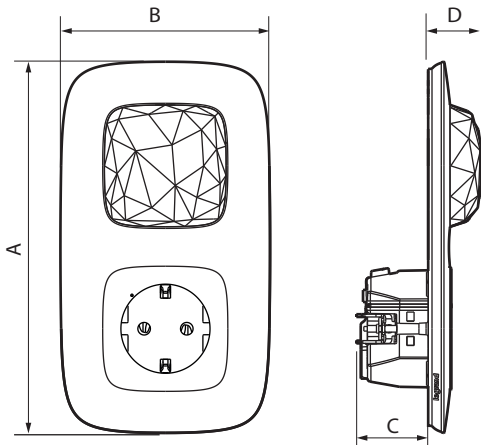

References	A	B	C	D
7 525 96 - 7 526 96 - 7 527 96 - 7 528 96 - 7 529 96	162	91.5	31.5	23

4. OPERATION

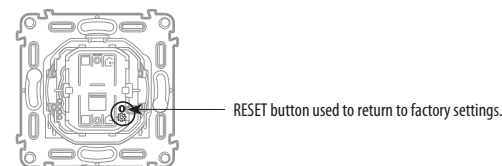
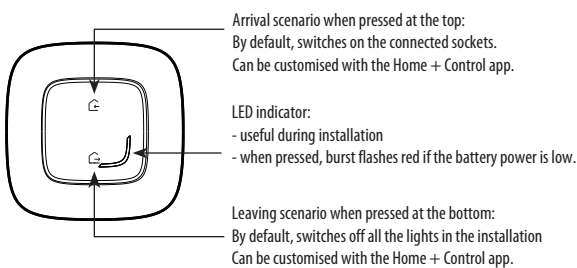
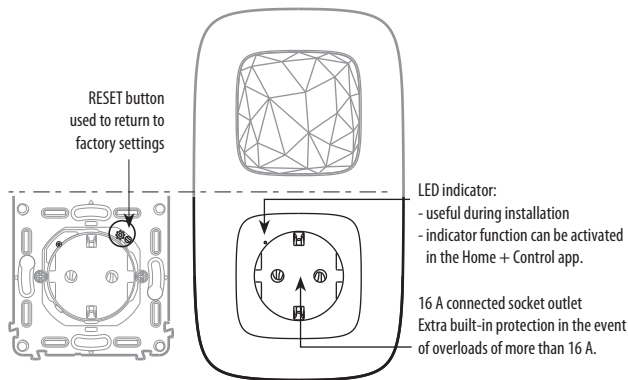

! The starter pack is pre-paired at the factory.
Never perform a factory RESET on the control socket and the wireless general control at the same time, as this may render them unusable.

5. CONNECTION

Control socket
 Terminal type: automatic
 Terminal capacity: 2 x 2.5 mm²
 Stripping length: 11 mm

6. TECHNICAL CHARACTERISTICS

6.1 Mechanical characteristics

Control socket:
 Protection against impacts: IK 04
 Protection against solid bodies and/or liquids:
 IP 20 without cover plate and plate
 IP 40 assembled product

General control:
 Protection against impacts: IK 02
 Protection against solid bodies and/or liquids:
 IP 20 without rocker plate and plate
 IP 40 for assembled product

6.2 Material characteristics of control socket

Plate: ABS
 Sub-plate: PC
 Cover plate: PC
 Mechanism casing: PC
 Support: Fibreglass-reinforced (20 %) PC Grey RAL 7016
 Halogen-free
 UV resistant

Self-extinguishing:
 850° C / 30 s for insulating parts holding live parts in place.
 650° C / 30 s for the other insulating components.

6.3 Material characteristics of general control

Plate: ABS
 Sub-plate: PC
 Rocker plate: ABS
 Mechanism casing with grid: Fibreglass-reinforced (10 %) PC
 Halogen-free
 UV resistant

Self-extinguishing: 650° C / 30 s

6.4 Electrical characteristics of control socket

Voltage: 110/230 V~
 Current: 16 A
 Power: 3680 W max.
 Frequency: 50/60 Hz
 Standby consumption: 0.1 mA

WiFi technology 2.4 GHz (13 channels) - IEEE 802.11 b/g/n

ZigBee radio technology frequency: 2.4 GHz to 2.4835 GHz
 Wireless mesh network, self-adaptive and secure (AES 128), conforming to standard IEEE 802.15.4 (LR-WPAN)
 Power level: REC 70-03 < 20 dBm

Range: 200 m of unobstructed space
 10 m recommended between products indoors

6.5 Electrical characteristics of general control

Powered by a CR2032 - 3 V lithium battery (supplied)
 Battery life: 8 years for 10 activations a day

ZigBee radio technology frequency: 2.4 GHz to 2.4835 GHz
 Wireless mesh network, self-adaptive and secure (AES 128), conforming to standard IEEE 802.15.4 (LR-WPAN)
 Power level: < 100 mW

6.6 Climate characteristics

Storage temperature: 0° C to + 45° C
 Usage temperature: + 5° C to + 45° C

7. CARE

Clean the surface with a cloth.
Do not use acetone, tar-removing cleaning agents or trichloroethylene.

Resistant to the following products: Hexane (EN 60669-1), methylated spirit, soapy water, diluted ammonia, bleach diluted to 10%, window-cleaning products, pre-impregnated wipes.

The plates must not be painted.

Caution: Always test before using special cleaning products.



Take care to recycle the battery appropriately.

8. ACCESSORIES

0 648 71: Repositionable adhesive for wireless control (x 4 supplied)

9. STANDARDS AND APPROVALS

The undersigned, LEGRAND, declares that the radio-electric equipment type (7 525 96 - 7 526 96 - 7 527 96 - 7 528 96 - 7 529 96 - 7 521 86 - 7 525 86 - 7 526 86 - 7 527 86 - 7 528 86 - 7 529 86) complies with directive 2014/53/EU.

The full text of the EU declaration of conformity is available on the following website: www.legrandoc.com