

Mosaic™

Cat. No(s): 0 772 02/03/22/23/32/33/42/43

**Sockets for installation on DLP trunking with direct connection
 German standard**

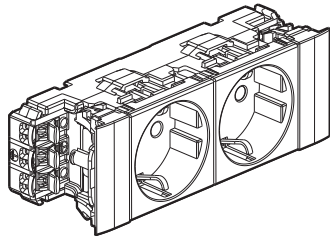

0 772 02

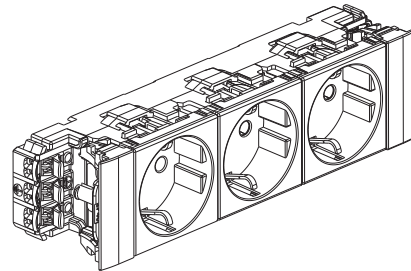

0 772 03

1. DESCRIPTION

Sockets with connection at both sides for snap-on mounting on trunking. These sockets incorporate the Soluclip accessory to hold the socket in place and comply with standard EN 50085-2-1 (the IP 40 rating should not be affected by the cut-out in the cover).

2. RANGE

2 x 2P+E socket outlets - 4 modules

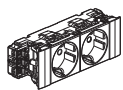

○ White	0 772 02
● Red tamperproof	0 772 22
● Black	0 772 32
● Red	0 772 42

3 x 2P+E socket outlets - 6 modules

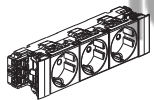

○ White	0 772 03
● Red tamperproof	0 772 23
● Black	0 772 33
● Red	0 772 43

3. OVERALL DIMENSIONS (mm)

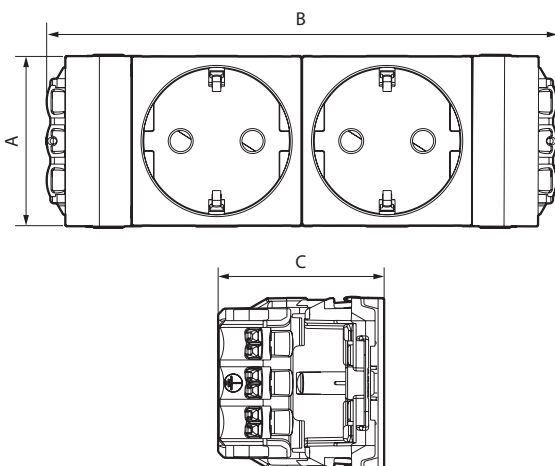

Catalogue numbers	A	B	C
0 772 02/22/32/42	45	135	44
0 772 03/23/33/43	45	180	44

4. CONNECTION

Type of terminals: automatic
 Number of terminals: 6
 Terminal capacity: 2 x 2.5 mm²
 Stripping length: 10 mm

5. TECHNICAL CHARACTERISTICS

■ **5.1 Mechanical characteristics**

Impact tests: IK 04
 Protection against solid bodies and liquids: IP 40

■ **5.2 Material characteristics**

Base: ABS
 Cover plate: PC
 Halogen free
 UV resistant
 Self-extinguishing:
 + 850°C/30 s for insulating parts holding live parts in place
 + 650°C/30 s for other parts made of insulating materials.

■ **5.3 Electrical characteristics**

Voltage: 250 V~
 Current: 16 A

■ **5.4 Climatic characteristics**

Storage and use temperature: -15°C to +70°C

6. MAINTENANCE

Surface cleaning with a cloth.
 Do not use: acetone, tar remover, trichloroethylene.

Caution: A preliminary test should be carried out if other specific cleaning products are to be used.

Sockets for installation on DLP trunking with direct connection German standard

7. ACCESSORIES

Tamperproof insert

	● Red Fixes directly onto the 2P+E plug of the appliance to be connected to the tamperproof socket.	0 502 99
---	--	----------

Cable end fitting

	Prevents tension on the connection between the wire and socket if the cable is pulled.	0 898 07
---	--	----------

Quick tap-off accessory

	For quick, simple tap-off between 2 socket blocks for trunking. Fitted with a white cover.	0 771 06
---	---	----------

■ Operating principle for the tap-off accessory

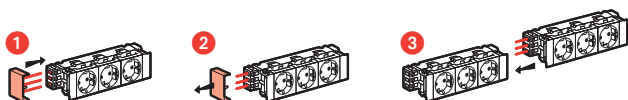

Simple, intuitive tap-off from 2 socket blocks.
The tap-off accessory also acts as a finishing piece for the 2 socket blocks.

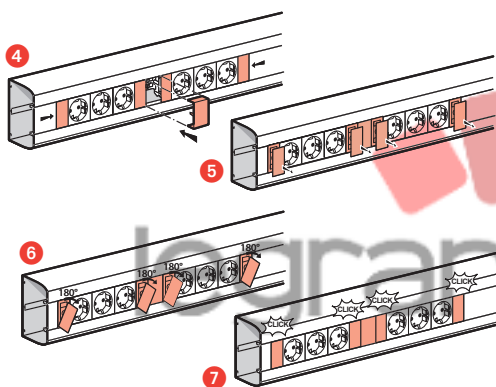

8. STANDARDS AND APPROVALS

Compliance with standards of installation and manufacturing.
Refer to e-catalogue.