

Valena Life™
Finish plates Link

Cat. No(s): 7 541 21/22/23/24/25

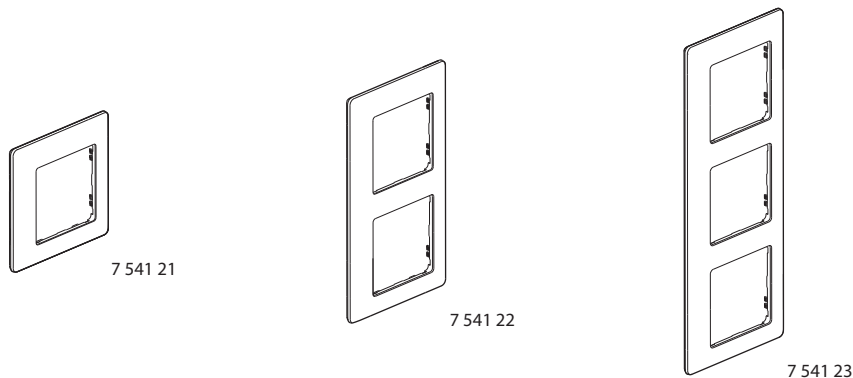



1. USE

Frame plates for fitting on Valena mechanisms 1 to 5 gangs.

2. RANGE

PLATES SUPPLIED WITH WHITE TRANSPARENT UNDER-PLATES

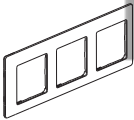
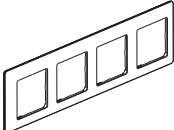
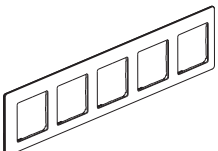
	1-gang	7 541 21
	2-gang	7 541 22
	3-gang	7 541 23
	4-gang	7 541 24
	5-gang	7 541 25

3. OVERALL DIMENSIONS (mm)

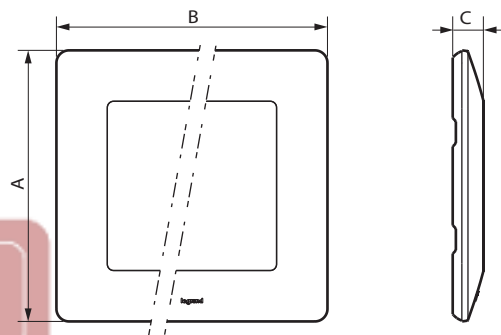

Catalogue Numbers	A	B	C
7 541 21	86	86	9.8
7 541 22	86	157	9.8
7 541 23	86	288	9.8
7 541 24	86	299	9.8
7 541 25	86	370	9.8

4. MOUNTING

The plates are clipped via notches to screw-type or claw-type supports (the notches are used to compensate for the thickness. Example: wall carpet). The plates are fitted with a protective film that is to be removed before use. Easy to remove with a screwdriver using the slots on the side of the plate.

5. TECHNICAL DATA

■ **5.1 Mechanical characteristics**

Impact tests: IK 04

■ **5.2 Material characteristics**

Decor plates: ABS
 Under-plates: PC
 UV resistant
 Halogen free
 Self-extinguishing: 650° C / 30 s

■ **5.3 Climatical characteristics**

Storage temperature: - 10° C to + 70° C
 Use temperature: - 5° C to + 50° C

6. CLEANING

Surface cleaning with a cloth.

Do not use: acetone, tar remover, trichloroethylene.

Dish-washer proof.

■ 6.1 Resistance to the following cleaning substances

- Hexane (EN 60669-1),
- Methylated spirit,
- Soapy water,
- Diluted ammonia,
- Diluted pure bleach 10%,
- Glass cleaning product,
- Pre-impregnated wipes.

■ 6.2 Resistance to the following hospital-type cleaning substances

- Anios,
- Surfanios,
- Bactily sine,
- Hydrogen peroxide (oxygenated water 35%).

Caution: A spot test should be carried out before using any other specific cleaners.

7. SPECIAL USE

The plates must not be painted.

