

Céliane™
LED lighting

Cat. No(s): 0 676 52/54/55 - 0 680 54 - 0 683 54

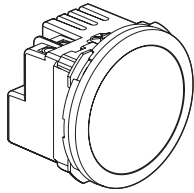

0 676 52

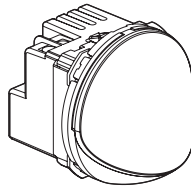

0 676 54 + 0 680 54
 0 676 54 + 0 683 54

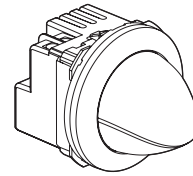

0 676 55
 Rotation totale
 de l'enjoliveur

1. USE

For specific directionnal lighting in harmony with Céliane wiring devices range.

2. RANGE

References	Colours	Description	General characteristics	Life
0 676 52	-	Céliane marker light: illuminates a circulation zone.	Luminous flux: 90 lm - Power input: 2.4 W Color temperature: 3,000 K, neutral white	50 000 hours
0 676 54 0 680 54 0 683 54	White cover Titane cover	Céliane stair light + covers: lights and decorates a staircase.	Luminous flux: 70 lm with cover Power input: 2.2 W Color temperature: 3,000 K, neutral white	50 000 hours
0 676 55	-	Céliane directional light: illuminates a worktop. Supplied with a matt chrome cover.	Luminous flux: 70 lm - Power input: 2.8 W Color temperature: 3,000 K, neutral white	50 000 hours

3. PREPARATION

p : ≥ 40 mm

■ Mounting

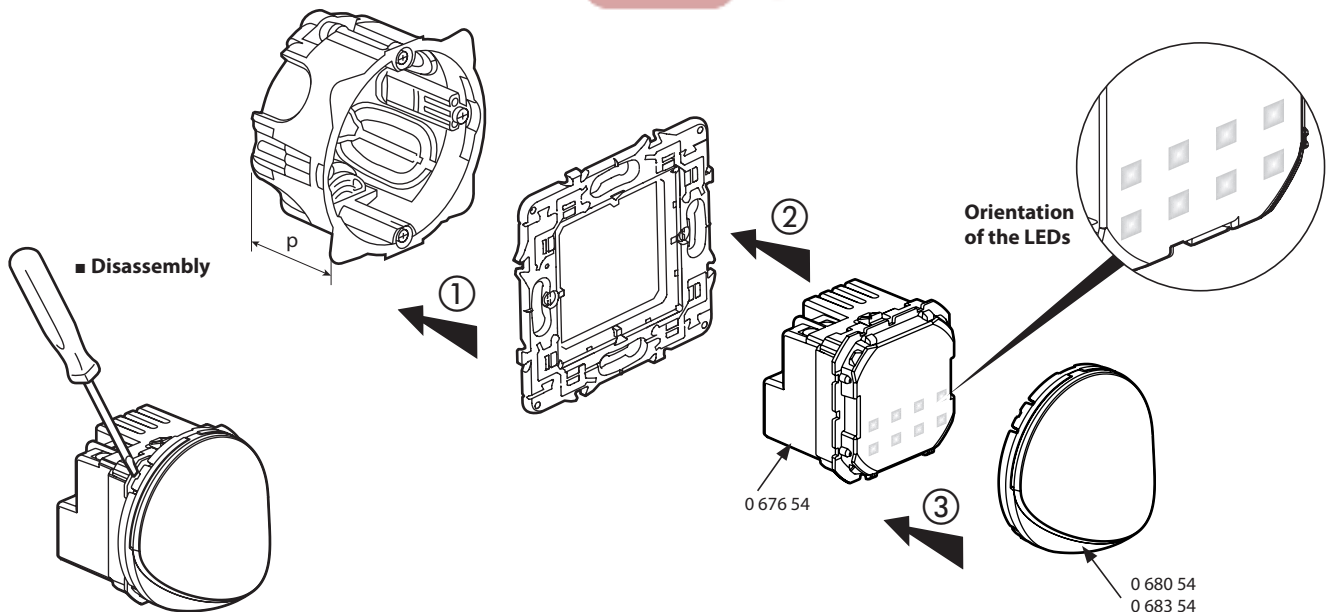

4. OVERALL DIMENSIONS (mm)

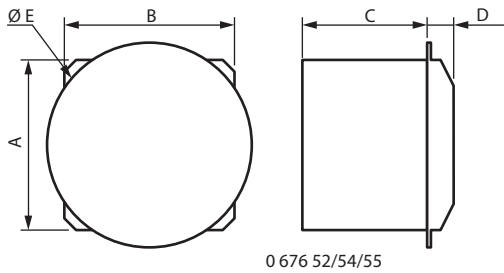

Cat. Nos	A	B	C	D	Ø E
0 676 52	45	45	33	7	53
0 676 54	45	45	33	25	53
0 676 55	45	45	33	34	53

5. CONNECTION

Terminal capacity: 2 x 1.5 mm² or 2 x 2.5 mm²
 Connection type: with screws
 Screwdriver: Flat 3 mm
 Stripping length: 8 mm
 Tightening torque: 0.5 Nm

6. TECHNICAL CHARACTERISTICS

■ 6.1 Protection index

Penetration by solid bodies/liquid: IP 20 unassembled
 IP 40 assembled

Impact test: IK 04

■ 6.2 Material characteristics

Material:

- Cover: PC
 - Diffuser: PC
 - Painted cover: ABS
- Halogen free.
 UV resistant.

Self-extinguishing:

- + 850° C / 30 s for insulating parts holding live parts in place.
- + 650° C / 30 s for other parts made of insulating materials.

■ 6.3 Electrical characteristics

Voltage: 230 VAC

Frequency: 50 Hz

Current: 70 mA

Life: 50 000 hours

The LED lighting products ref. 0676 52/54/55, can be controlled by:

- mechanical switches,
- electronic switches with neutral such as automatic switches with neutral 3 wires,
- sensitive switch with neutral,
- controllers My Home,
- My Home radio switches with neutral ...

Note: the spot lights cannot be managed by a dimmer switch.

6. TECHNICAL CHARACTERISTICS (continued)

■ 6.4 Photoelectric characteristics

Stair light Cat. No 0 676 54 with cover 0 680 54 or 0 683 54

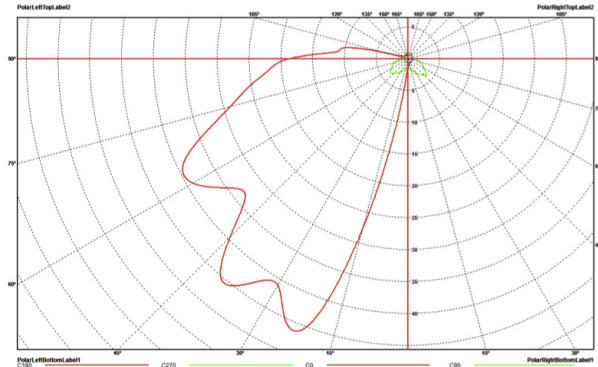
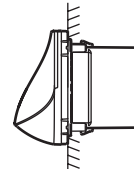

Spot light Cat. No 0 676 52

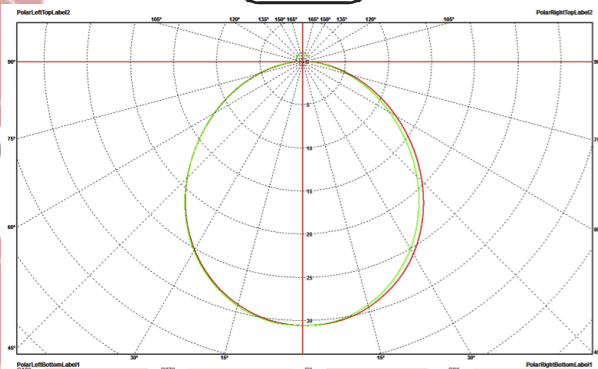
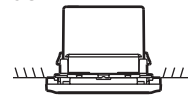

6. TECHNICAL CHARACTERISTICS *(continued)*

■ 6.4 Photoelectric characteristics

Directional light Cat. No 0 676 55

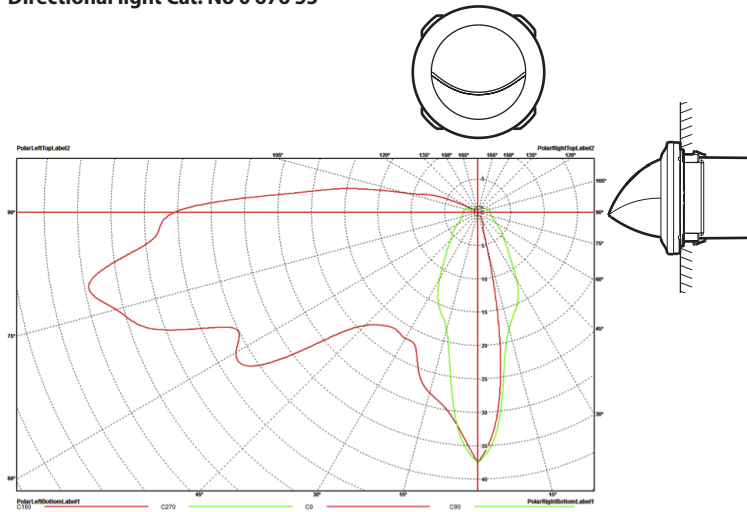

■ 6.5 Climatic characteristics

Storage temperature - 25° C to + 45° C

Use temperature: - 5° C to + 35° C

7. CLEANING

Surface cleaning with a cloth.

Do not use: acetone, tar remover, trichloroethylene.

Caution: A preliminary test should be carried out if other specific cleaning products are to be used.

8. STANDARDS AND APPROVALS

IEC 60598-1
IEC 60598-2-2
IEC 61547
IEC 60669-2-1