

<p>12-15 V$\overline{\text{---}}$</p>	<p>MONO 1 x 1 W STEREO 2 x 1 W</p>	<p>87,5 MHz ↓ 108 MHz</p>	<p>10 max.</p>

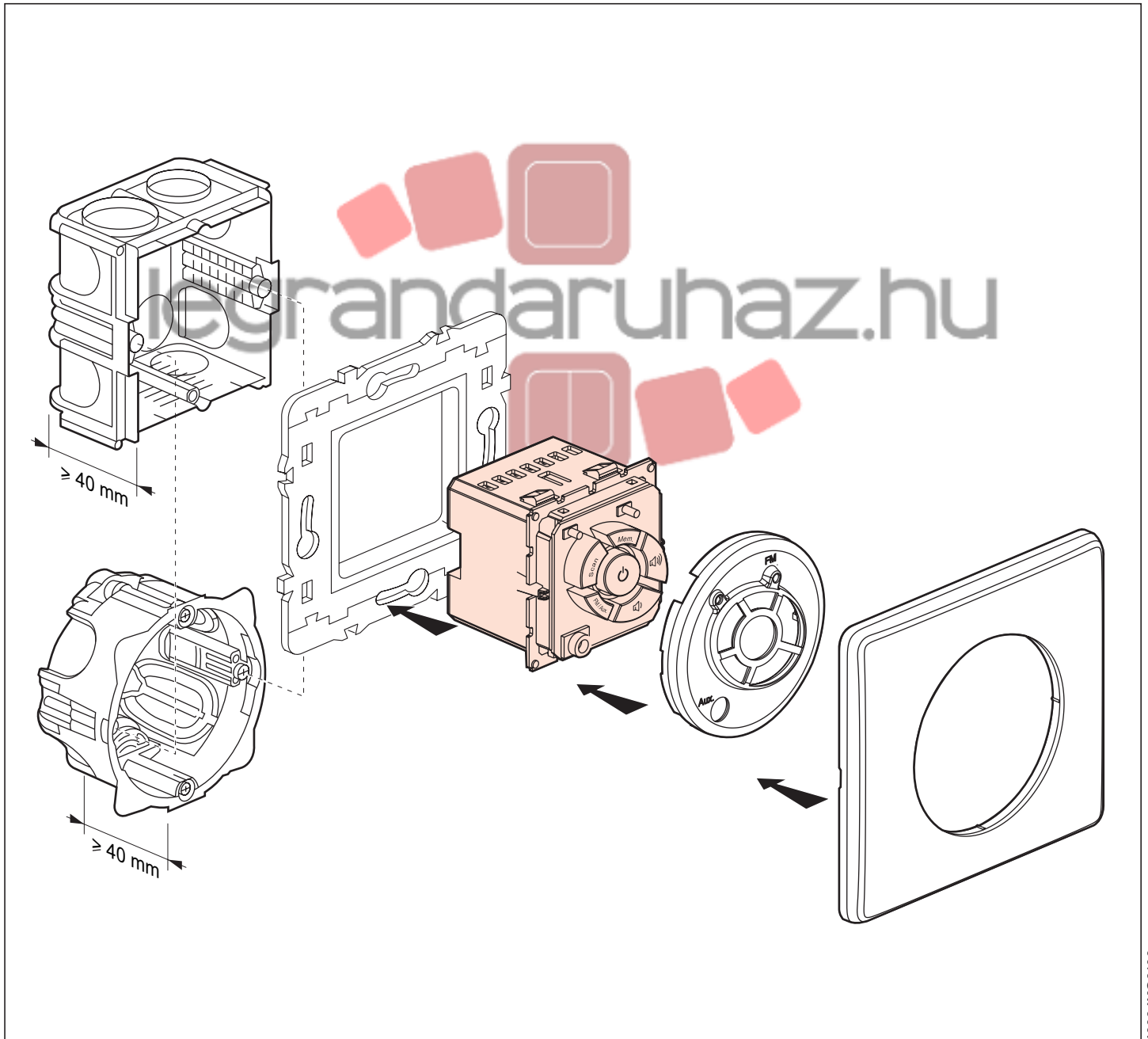

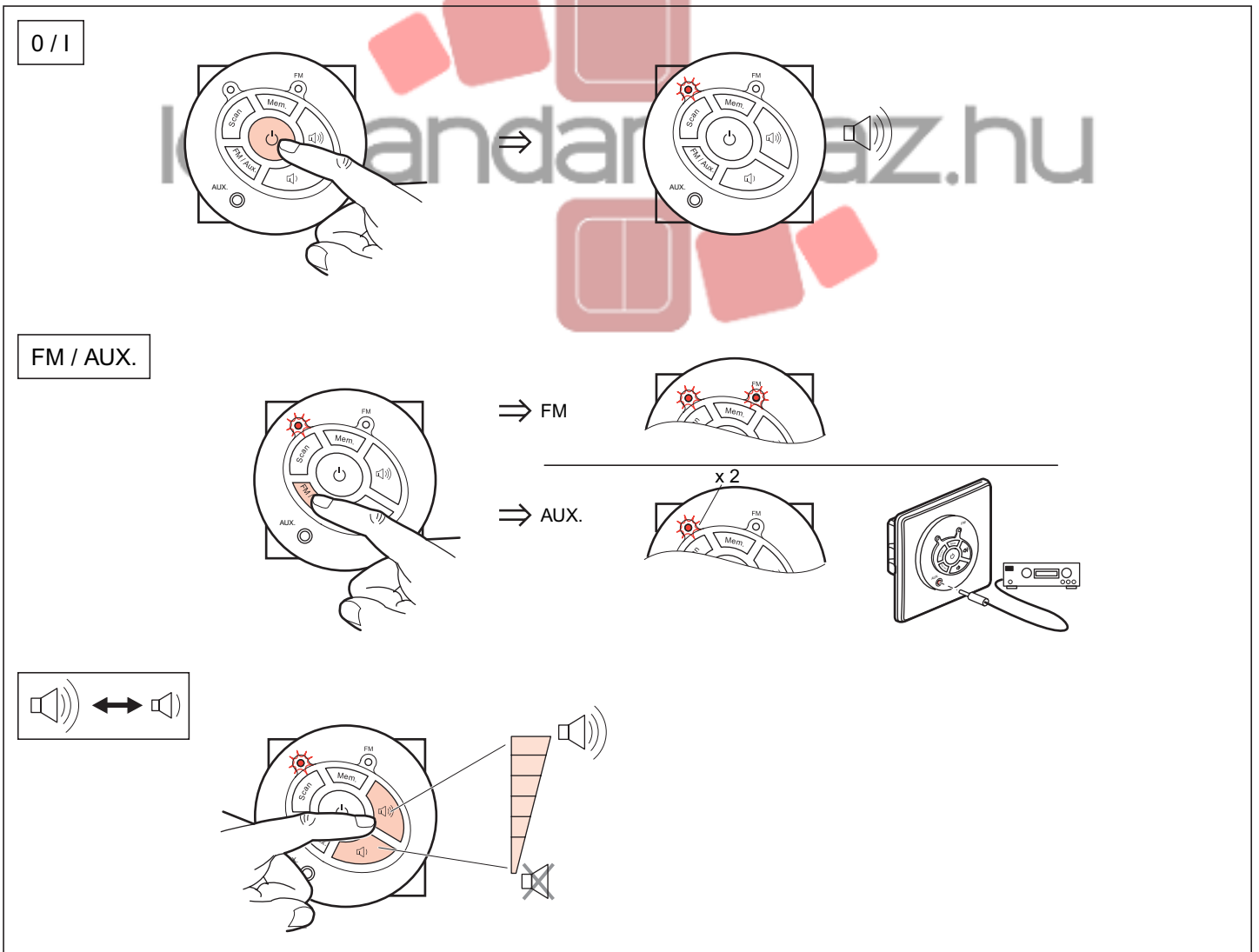

FM → SCAN

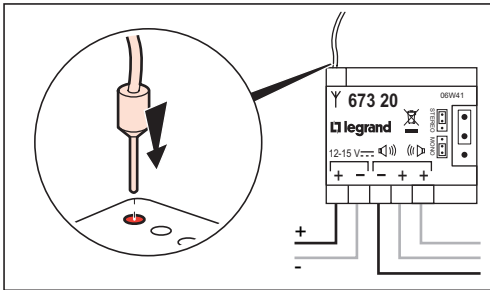
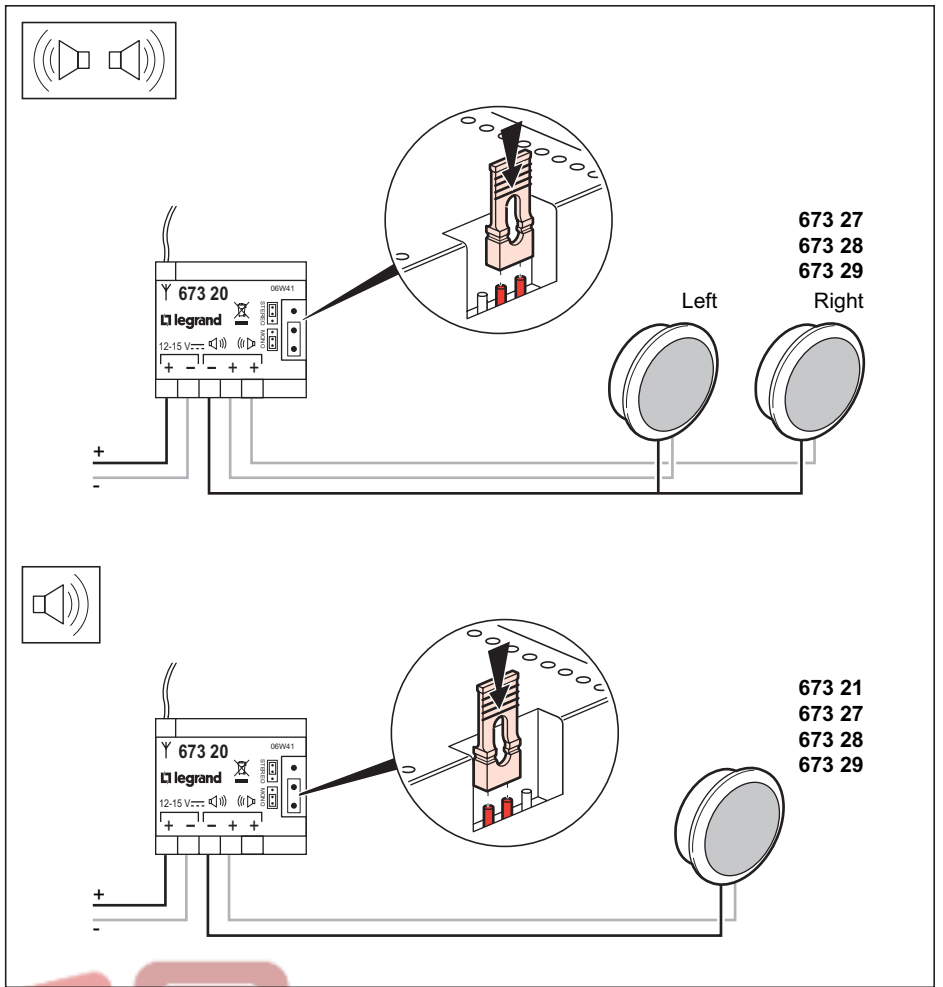
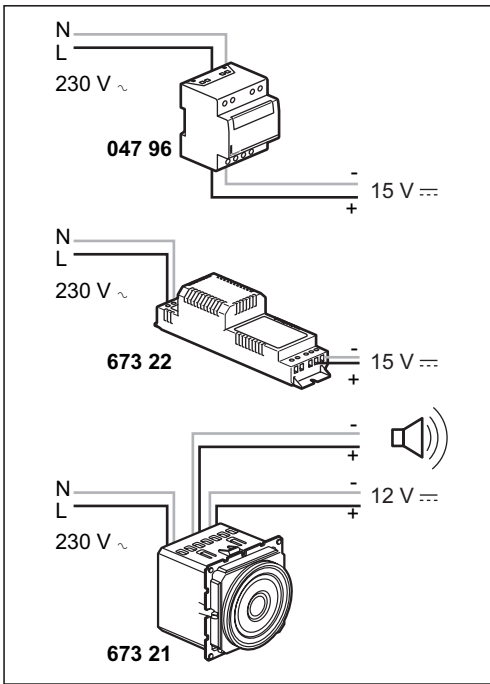
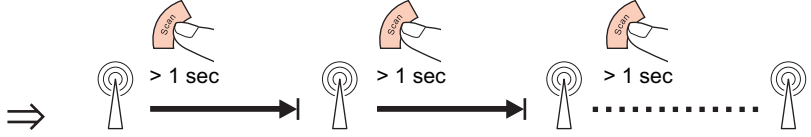
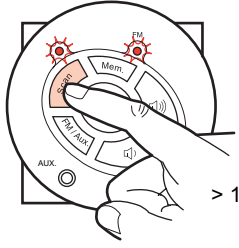
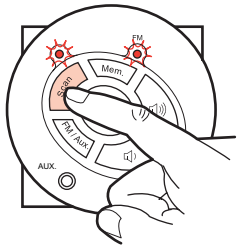

FM → MEM

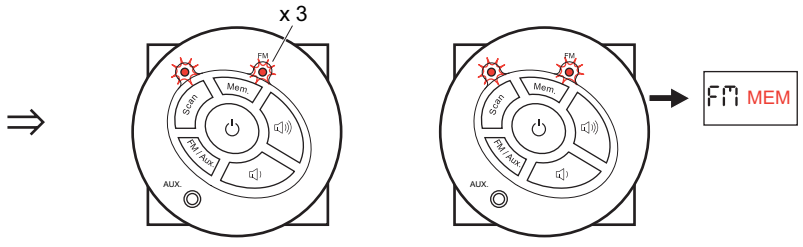
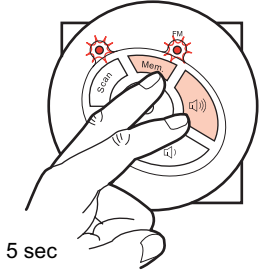

FM → MEM AUTO

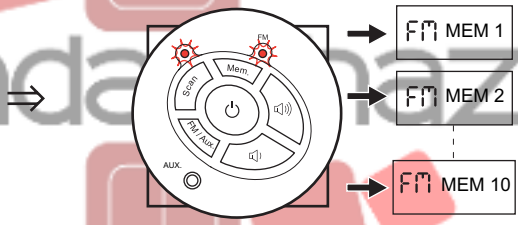
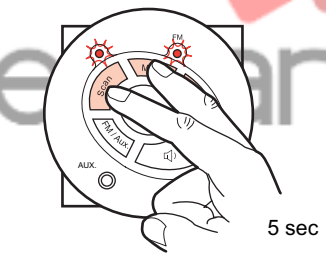

SELECTION MEM

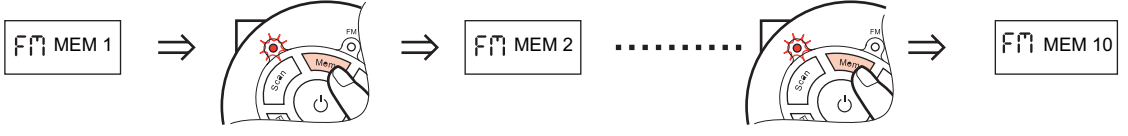

FM → ~~MEM~~

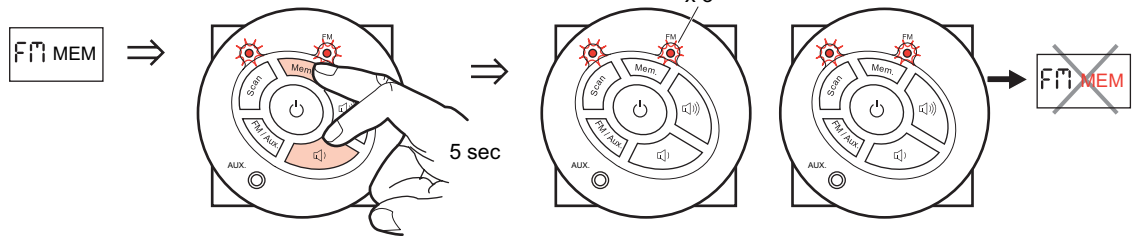

 → SENSITIVITY
FM

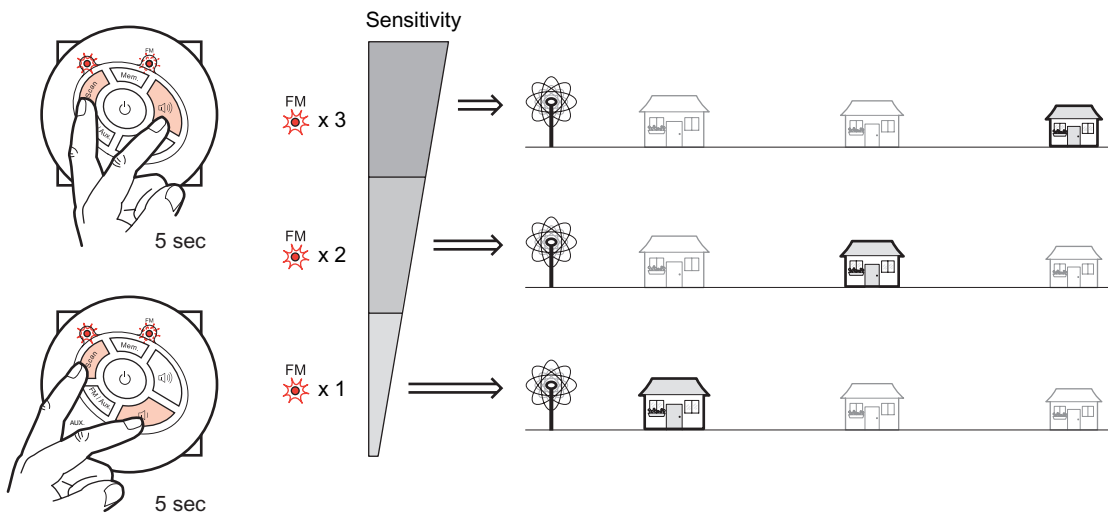

Si malgré les réglages, la qualité de réception reste mauvaise, nous consulter.

 | → 0

